

Science and Technology Create Perfection

# Installation and Operating Manual

## **SR961/SR962**

# **SOLAR STATION**

For Split Pressurized Hot Water System

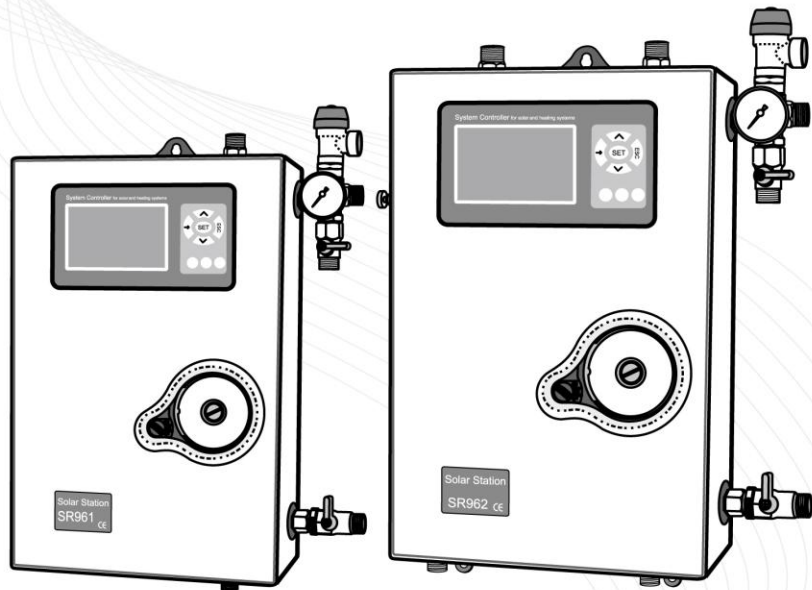

*Read the instruction carefully please before operation!*

## Contents

1. Safety information-----	3
1.1 About this manual-----	3
1.2 Liability waiver-----	3
1.3 Important remark-----	3
1.4 Description of symbols-----	4
2. Overview of solar station-----	4
2.21 Technical date of solar station SR961 & SR962 -----	7
3. Mounting of solar station-----	9
4. Attention Items for solar station installation -----	9
5. Wire connection of solar controller-----	11
5.1 Open the connection box-----	11
5.2 Change fuses-----	12
5.3 Terminal connection-----	12
6. Control operation description-----	14
6.1 Operation button-----	14
6.2 Signal description-----	15
6.3 Time / week setup-----	16
6.4 Menu structure-----	17
6.5 Menu description-----	18
6.6 System description-----	19
6.6.1 System(1 collector array – 1 tank – 1 pump –auxiliary heating)-----	19
7. Functional parameter setup-----	20
7.1 Access to main menu-----	20
7.2 Access to submenu-----	20
7.3 Main menu - THET Timing heating-----	21
7.4 Main menu - tCYC Temperature and time in three time section for DHW hot water-----	24
7.5 Main menu - DT Temperature difference function-----	28
7.6 Main menu TEMP Temperature-----	29
7.6.1 Submenu - EMOF Collector safety switch-off temperature-----	30
7.6.2 Submenu - CMX Maximum limited collector temperature( collector cooling function)-----	31

7.6.3 Submenu - CMN	Low temperature protection of collector-----	32
7.6.4 Submenu - CFR	Frost protection of collector-----	33
7.6.5 Submenu - REC	Tank recooling temperature-----	34
7.6.6 Submenu - SMX1	Maximum temperature of tank-----	34
7.6.7 Submenu -	C-F Celsius and Fahrenheit temperature transferring-----	35
7.7 Main menu - FUN	Auxiliary function-----	35
7.7.1 Submenu - DVWG	Anti-Legionella function-----	36
7.7.2 Submenu - CIRC	Activate and deactivate DHW hot water circulation pump -----	36
7.7.3 Submenu - nMIN	Solar circuit pump speed adjusting (RPM speed controlling) -----	37
7.7.3.1 Submenu - DTS	Standard temperature difference (for circuit pump's speed adjusting) -----	37
7.7.4 Submenu - FMAX	Flow rate-----	38
7.7.5 Submenu - AHO/AHF	Tank thermostat function-----	38
7.8 Mainmenu - HND	manual function-----	40
7.9 Mainmenu - PASS	password setup-----	41
7.10 Mainmenu - RSET,	Recovery to factory set-----	42
7.11 On/Off button-----		42
7.12 Holiday function-----		42
7.13 Manual heating-----		43
7.14 Temperature query function-----		44
8. Protection function-----		44
8.1 Memory protection-----		44
8.2 Screen protection-----		44
9. Trouble shooting-----		45
9.1 Trouble protection-----		45
9.2 Trouble checking-----		46
10 Quality Guarantee-----		48
11. Technical data-----		49
12. Delivery scope-----		50
13. Devices matchable to this controller-----		50

## 1.Safety information

### 1.1 About this manual

This manual describes the installation, function and operation of a solar station, which integrates a solar controller. When installing the remaining components e.g. the solar collectors, pump assemblies and the storage unit, be sure to observe the appropriate installation instructions provided by each manufacturer.

Installation, electrical connection, commissioning and maintenance of the device may only be performed by trained professional personnel. The professional personnel must be familiar with this manual and follow the instructions contained herein.

### 1.2 Liability waiver

The manufacturer cannot monitor the compliance with these instructions or the circumstances and methods used for installation, operation, utilization and maintenance of this controller. Improper installation can cause damages to material and persons. This is the reason why we do not take over responsibility and liability for losses, damages or cost that might arise due to improper installation, operation or wrong utilization and maintenance or that occur in some connection with the aforementioned. Moreover we do not take over liability for patent infringements or infringements – occurring in connection with the use of this controller- on third parties rights. The manufacturer preserves the right to put changes to product, technical data or installation and operation instructions without prior notice. As soon as it becomes evident that safe operation is no longer possible (e.g visible damage). Please immediately take the device out of operation. Note: ensure that the device cannot be accidentally placed into operation.

### 1.3 Important remark

We have carefully checked the texts and pictures of this manual and provided the best of our knowledge and ideas, however inevitable errors may exist. Please note that we can not guarantee that this manual is given in the integrity of image and text, they are just some examples, and they apply only to our own system. Incorrect, incomplete and erroneous information and the resulting damage we do not take responsibility.

## 1.4 Description of symbols



**Safety symbol:** Safety instructions in the text are marked with a warning triangle. They indicate measures which can lead to injury of persons or safety risks.

**Operation steps:** small triangle “▶” is used to indicate operation step.

**Notes:** Contains important information on operation or function.

## 2. Overview of solar station

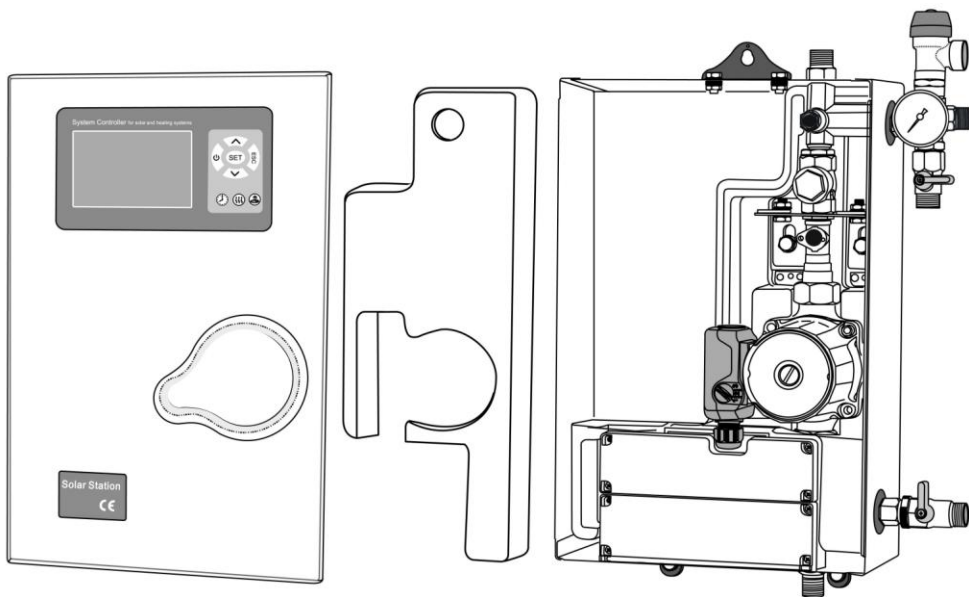

SR961 single pipeline system

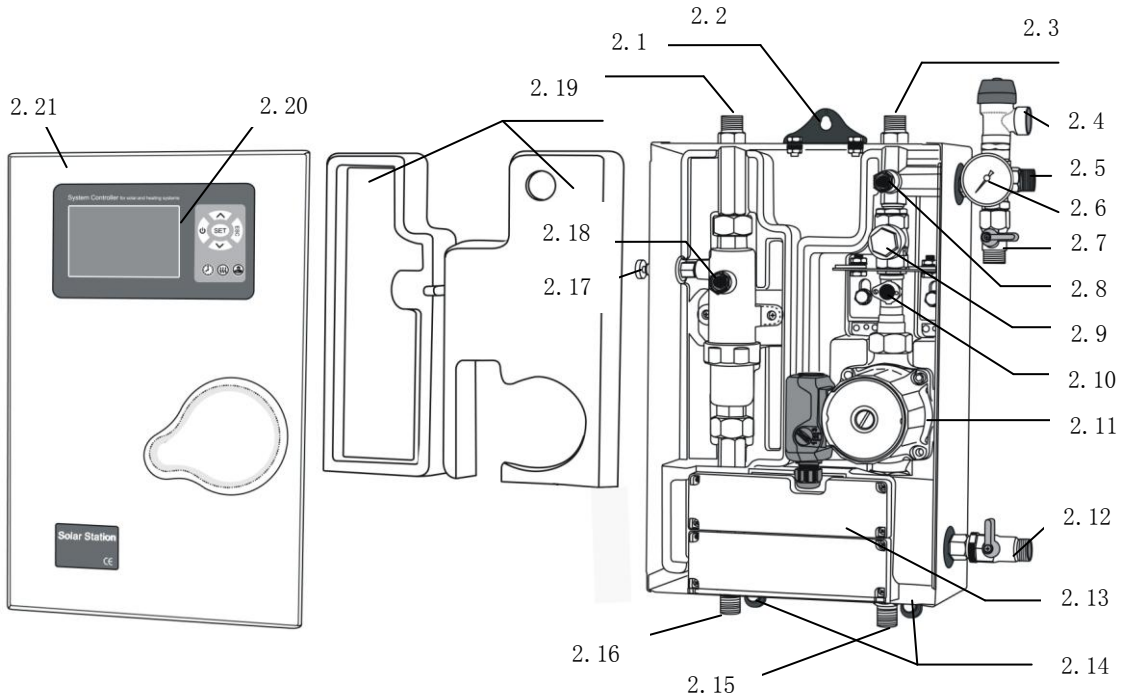

SR962 double pipeline system

SR961: Solar station with one pipe,

SR962: solar station with double pipes ,

This picture is according to SR962

2.1 Connection from collector ,male thread G1/2, (not exist on SR961)

2.2 Upper mounting hole

2.3 Connection to collector, male thread G1/2

2.4 Safety valve, 6bar

2.5 Connection to expansion tank, male thread G1/2

2.6 Solar circulation pressure gauge, measure range 0-10bar

2.7 Filling connection, male thread G1/2

2.8 Flow temperature sensor, NTC10K,B=3950

2.9 Gravity valve ( flow direction)

2.10 Digital water flow meter

2.11 Solar circulation pump

- 2.12 Discharge valve connection, male thread G1/2
- 2.13 Connection box of controller
- 2.14 Bottom mounting hole
- 2.15 Connection from tank, male thread G1/2
- 2.16 Connection to tank, male thread G1/2 ( not exist on SR961)
- 2.17 Air saperator including manual release valve (not exist on SR961)
- 2.18 Return pipe temperature sensor, NTC10K, B=3950(not exist on SR961)
- 2.19 Front insulation cover
- 2.20 Operation panel of controller
- 2.21 Front protection cover of solar station.

## 2.21 Technical data of solar station SR961 & SR962

Parts description of solar station	Parameter	Remark
<b>Solar station</b>		
Height	420mm	
Width	280mm	
Thickness	140mm	
Distance between flow/return	160mm	
Max. permitted pressure	10 bar	
Max. permitted temperature	130℃	
Pipe connections	4*G1/2 for SR962 Or 2*G1/2 for SR961 male thread	
<b>Safety devices</b>		
Safety valve pressure	6bar	
Manometer	0~10bar	
Connector for expansion tank	G1/2,male thread	
<b>Circulation pump</b>		
Type of pump	Wilo RS15/6	
Max. flow rate	2.5(t/h)	
Max. pump head	5.5m	
Max. operation pressure	10bar	
Medium temperature	-10~110℃	
Power supply	220V, 50-60HZ	
<b>Shut-off and display unit</b>		
Ball valve	G1/2	



<b>Gravity brake</b>		
Output	0~16bar	
Version		
Max. permitted temperature	-20~120℃	
<b>Flowmeter</b>		
Display/setting range	0.1~20L/min	
<b>Air seperator ( no in SR961)</b>		
<b>Connections for flushing/filling unit</b>		
For hose fitting	G1/2	
<b>Thermal insulation</b>		
Material for back and front casing	EPS/EPP	2 kinds of material can be chose
Material for front cover	St14	
<b>Integrated solar controller</b>	See manual of controller	
Return pipe temperature sensor	NTC10K, B=3950	
Flow pipe temperature sensor	NTC10K, B=3950	

### 3. Mounting of solar station

- ▶ Drill the upper fixing hole
- ▶ Fasten the screw
- ▶ Mark the bottom fixing hole
- ▶ Drill the bottom hole
- ▶ Fasten the bottom screw



### 4. Attention Items for solar station installation

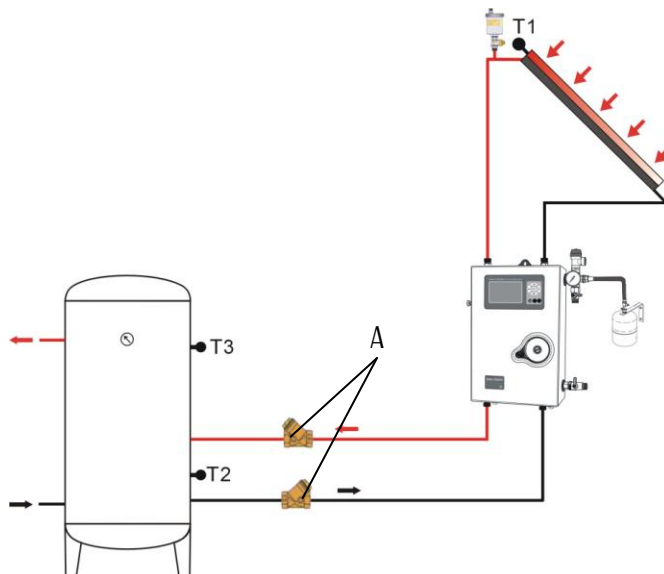

- If water is used as heat transfer liquid, then it is necessary to install a filter valve (A) on the inlet pipe and the return pipe of solar station, otherwise, the wheel of the flow meter can be stopped, as the result of that flow meter can't display the flow rate.
- All devices connected to the controller must conform to the technical specifications of the controller • Assembly, Installation and maintenance work may only be performed by properly qualified and authorized personnel with a generally recongnized qualification.
- The solar station must be installed indoors, prior to installation, remove sealing caps from solar station.
- Pre-setting, installing and adjusting the expansion tank as per the installation and operation instructions for “expansion tank”, the corrugated connection pipe for the expansion tank does not need thermal insulation.
- Safety valve: Risk of scadling from hot steam with discharge from the safety valve due to heating and excess pressure in the hydraulic pipes. Drain off discharge from the safety valve using a copper pipe correctly and in an eco-friendly way, according to valid technical regulations and load codes, do not allow solar fluid to leak into the environment.
- Be careful of scald from hot fluid. Maxiumu temperature of collectors during filling/leak check or installation/maintenance work should be below 70°C, allow collectors to cool down if necessary.
- Please ensure hydraulic connections are pressure-tight, connetions pipe should be insulated, Unused connections must be sealed tight with a suitable end plug.
- Air-seperator: if the system is pressue-tight ( no leakage), connect the power supply to the solar controller, using the manual mode of controller to circuit system for 15 minutes, then switch-off power supply, solar fluid is heated gradually, air dissolved in fluid is released out, through air –seperator to release air. If necessary ,repeats this process until no more aire is vented out. If the system pressure drops due to over air release, then it is necessary to refilling fliud to the required pressure.
- After filling the system, please check safety valve accoring to its manual.
- All safety regulations for working on the power supply are valid, All installtion and maintenace work should be performed when power is switched-off,

## 5. Wire connection of solar controller

### 5.1 Open the connection box

- ▶ Loosen the fixing screw (B) which is on the back of connection box

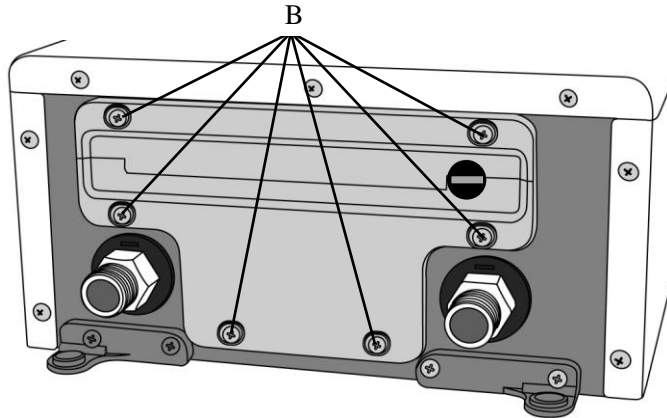

- ▶ Pull out the connection box downwards parallelly. ( C )
- ▶ Loosen the protection screw ( D ), open the cover of terminal upwards

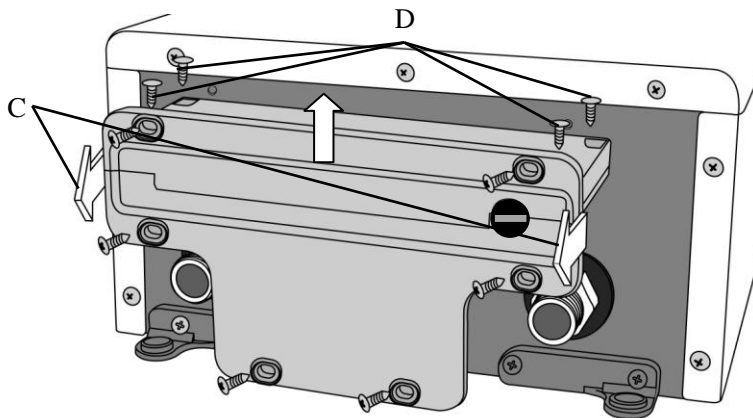

- ▶ Using proper tools ( like knife ) to take out the plastic ( E ) piece, wires can penetrate connection terminal through prepared holes.

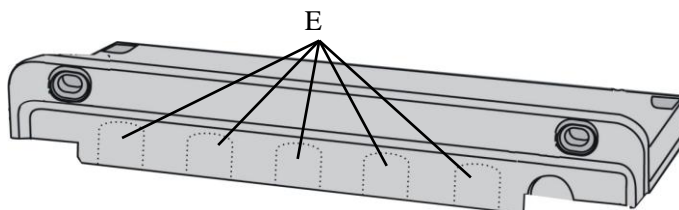

**Note:** Please use delivered clamps to fix wires correctly. ( F )

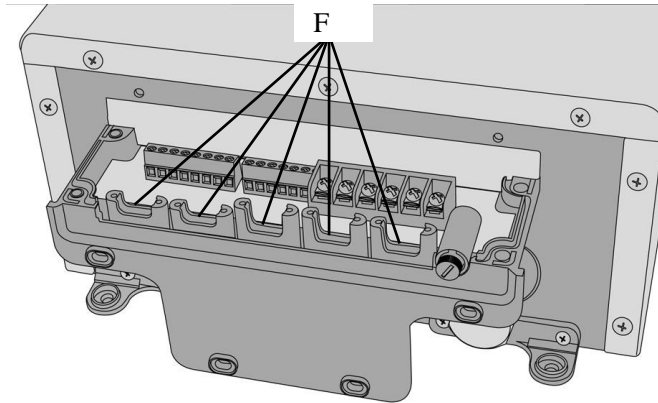

### 5.2 Change fuses

► Use screw driver(see as picture) , turn to left to spring fuse, fuse parameter: AC250V/6.3A

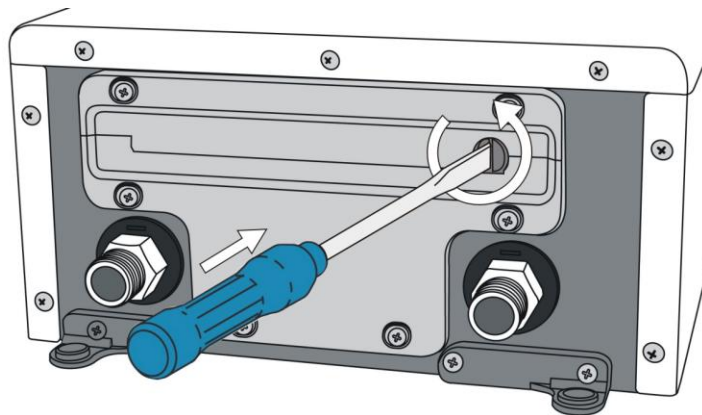

### 5.3 Terminal connection

- Layout of terminals

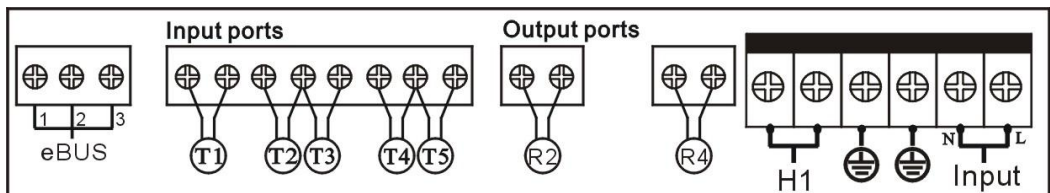

- **Power connection**

Input is for power connection,  is for connection with ground .

- **Input ports**

Input T1: PT1000 temperature sensor use for collector.

Input T2 ~T5: NTC10K, B=3950 temperature sensor, for measuring temperature of tank and pipeline

- **Advice regarding the installation of temperature sensors:**

Only original factory equipped Pt1000 temperature sensors are approved for use with the collector, it is equipped with 1.5meter silicon cable and suitable for all weather conditions, the cable are temperature resistant up to 280 °C, not necessary to distinguish the positive and negative polarity of the sensor connection.

Only original factory equipped NTC10K,B=3950 temperature sensors are approved for use with tank and pipe, it is equipped with 1.5meter PVC cable, and the cable are temperature resistant up to 105 °C, not necessary to distinguish the positive and negative polarity of the sensor connection.

All sensor cables carry low voltage, and to avoid inductive effects, must not be laid close to 230 volt or 400 volt cables (minimum separation of 100mm)

If external inductive effects are existed, e.g. from heavy current cables, overhead train cables, transformer substations, radio and television devices, amateur radio stations, microwave devices etc, then the cables to the sensors must be adequately shielded.

Sensor cables may be extended to a maximum length of ca. 100 meter, when cable's length is up to 50m, and then 0.75mm<sup>2</sup> cable should be used. When cable's length is up to 100m, and then 1.5mm<sup>2</sup> cable should be used.

- **Output ports**

**Output R2:**electromagnetic relay, max. switching current 3.5A,

R2 ports wire connection:for tank thermostat function

**Output R4:** electromagnetic relay, max. switching current 3.5A,

R4 ports wire connection:for hot water circuit pump function.

**Output H1:** electromagnetic relay , max. switching current 10A,

H1 connection ports: for eletrical heater

**Note:** Solar pump (installed on solar station) is already connected with controller, eletronmagnetic valve and sensor connections relay on the system you selected. Shielded cable should be used.

- eBus connector: for remote display ( optional )

Using solar remote displayer SR806, system temperature, circulation pump speed, accumulated operation time of circulation pump, week and clock can be displayed. And clock, manual heating functions can be set on it. Through eBUS connector to connect SR806 with main controller installed on solar station.

Port 1 connected with red wire ( +12V)

Port 2 connected with white wire ( COM)

Port 3 connected with black wire ( GND)

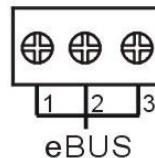

## 6. Control operation description

### 6.1 Operation button



Set button



exit/confirm



upwards



downwards



ON/OFF button



clock



manual heating



holiday

**Note:**











Connect the sensors, pumps or switching valves to the controller before you connect the

power supply!

After power is switched on, you can set time, password, select system and relevant parameters.

## 6.2 Signal description

Signal on displays shows current status. Their means explain in following table.

Signal	Display	Flash display
		Electrical heater is in active
		Collector safety temperature function is in active
		Tank urgency stop funtion is in active
	Collector cooling function is in active	
	Collector low temperature protection is	in active
		Collector frost protection function is in active
		Tank recooling function is in active
	Tank maximum temperature protection function is in active	
	Tank thermostate function is in active	in active
	Manual function is in active	
	Holiday function is in active	





### 6.3 Time / week setup

▶ Press  , display shows time, "00" blinks on hour area

▶ Press   button to adjust hour of clock.

▶ Repress  , "00" of minute area blinks

▶ Press   , to adjust minute of clock

▶ Repress  , "MO" of week blinks

▶ Press   , to adjust weekday

▶ Press "ESC" to exit setup menu, or wait for 20 seconds to exit ,set parameters are saved automatically.

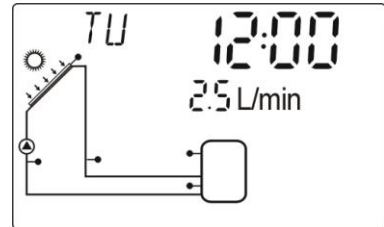

Code	Weekday
MO	Monday
TU	Tuesday
WE	Wednesday
TH	Thursday
FR	Friday
SA	Saturday
SU	Sunday

## 6.4 Menu structure

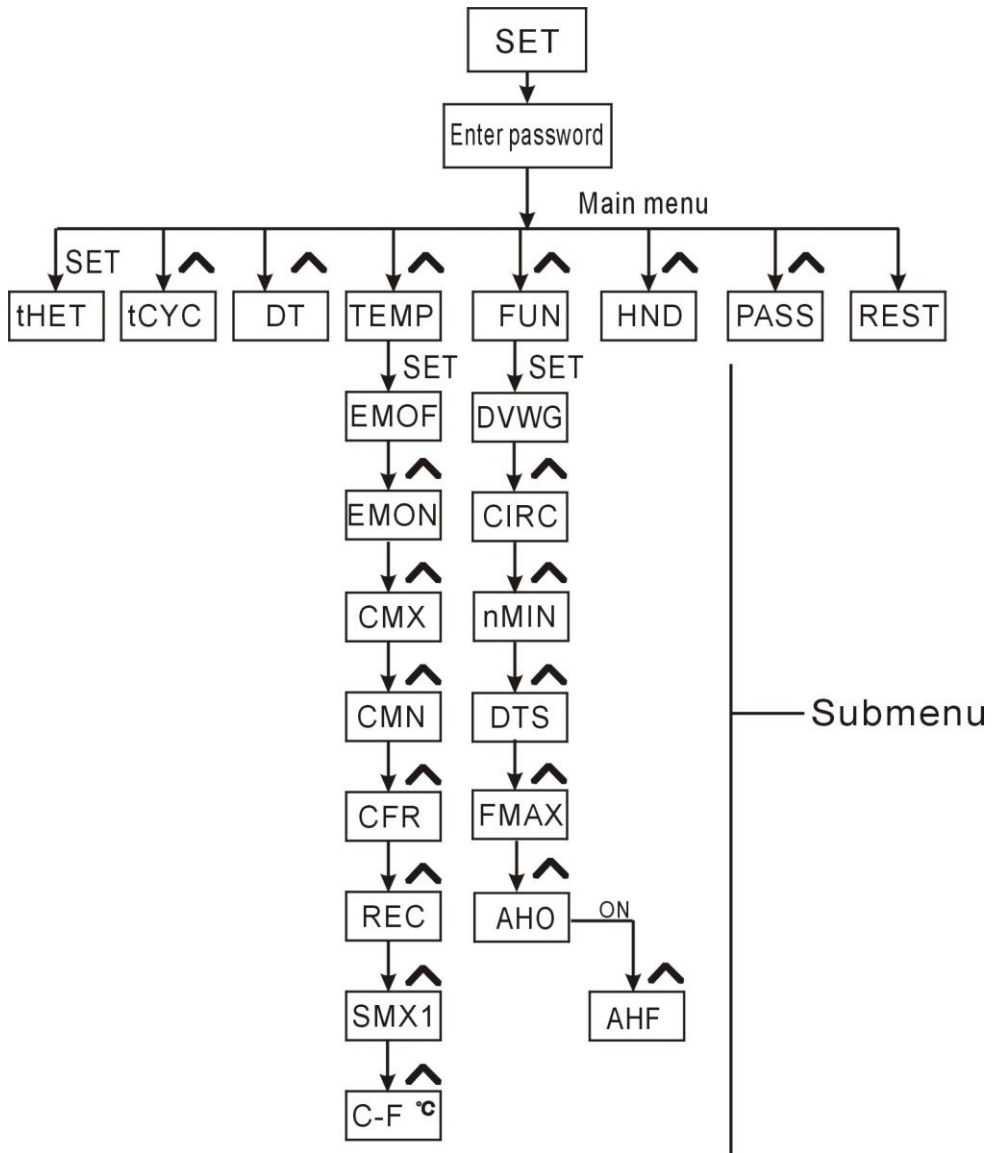

### Submenu:

Through submenu you can setup more detailed, please make sure to understand the content in submenu.

## 6.5 Menu description

Sr.Nr.	Code Main menu	Code submenu	Description
1	tHET		Timing heating in three time periods
2	tCYC		Temperature or time setting in three time periods for hot water circulation pump
3	DT		Temperature difference adjusting
4	TEMP		Temperature main menu
5		EMOF	Collector safety swith-off tmperature
6		EMON	Collector safety resume temperature
7		CMX	Maximum temperature of collector ( collector cooling function)
8		CMN	Low temperature protection of collector
9		CFR	Frost protection temperature of collector
10		REC	Tank recooling function
11		SMX1	Maximum temperature of tank
12		C-F	C-F temperature display transferring
13	FUN		Auxiliary functions
14		DVWG	Anti legionnaires'bacteria function
15		CIRC	Activate and deactivate DHW hot water circulation pump
16		nMIN	Speed controlling of circulation pump (RPM pump controlling)
17		DTS	Standard temperature difference (for circulation pump speed adjusting)
18		FMAX	Flow rate setting
19		AHO/AHF	Tank thermostat function
20	HDN		Manual operation
21	PASS		Passowrd setup
22	REST		Recovery to factory setup

## 6.6 System description

### 6.6.1 System(collector array – 1 tank – 1 pump –auxiliary heating)

#### Description:

The solar circuit pump (R1) is switched on as soon as the switch-on temperature difference ( $\Delta T_{on}$ ) between the collector array (T1) and the storage tank (T2) is reached. If the temperature difference between the collector array (T1) and storage tank (T2) drops below the switch-off temperature difference ( $\Delta T_{off}$ ), or the temperature of storage tank (T3) reaches the preset maximum storage temperature, then the solar circuit pump (R1) is switched off.

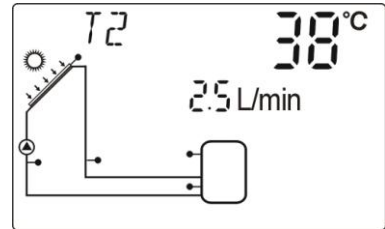

#### Back-up heating by auxiliary boiler (detailed see paragraph 7.3):

Within the preset time section of back-up heating, if the temperature T3 of tank drops below the switch-on temperature, then the circulation pump (H1) of back-up heating is triggered, when T3 is heated to the switch-off temperature, circulation pump H1 of back-up heating is ceased.

T1: Temperature sensor for collector

T2: Temperature sensor in the bottom of tank .

T3: Temperature sensor in the top of tank (optional sensor)

T5: Temperature sensor on DHW hot water return pipe (optional sensor)

T6: Temperature sensor flow into pipeline

T7: Temperature sensor return back pipeline

R1: Solar circuit pump ( connected on controller already)

R4: DHW Hot water circulation pump

H1: Output for back-up electrical heater

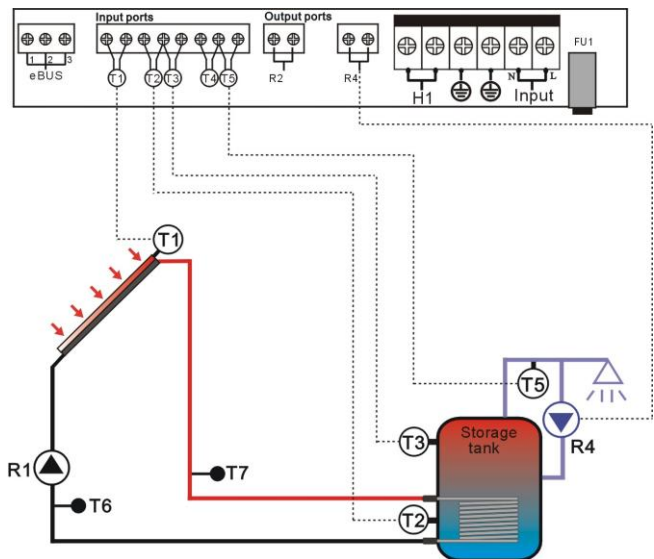

#### Note:

T3 is an alternative sensor, when no sensor (T3) is installed in the top of tank, controller will use the signal of sensor T2 automatically to control the auxiliary heating or the circulation pump.

## 7. Functional parameter setup

### 7.1 Access to main menu

Under standby status, doing like following to access main menu

- ▶ Press “SET” button, “PWD 0000” displays on screen, the left first digital blinks, ask for entering password, factory default set password is “0000”
- ▶ Press “ ^ v ” button to enter first digital of password.
- ▶ Press “SET” button again, the second digital blinks
- ▶ Press “ ^ v ” button to enter second digital of password
- ▶ Press “SET” button again, the third digital blinks
- ▶ Press “ ^ v ” button to enter the third digital of password
- ▶ Press “SET” button again, the fourth digital blinks
- ▶ Press “ ^ v ” button, to enter the fourth digital of password
- ▶ Press “SET” button again to access main menu
- ▶ Press “ ^ v ” button, can select the main menu for example.
- ▶ Press “ESC” button to exit main menu



For example

### 7.2 Access to submenu

After selecting main menu, do like following to access submenu

- ▶ Press “SET” button to access submenu
- ▶ Press “ ^ v ” button to select desired submenu
- ▶ Reprress “SET” button to access setup of submenu
- ▶ Press “ ^ v ” button to adjust parameter
- ▶ Reprress “SET” button to exit setup of submenu
- ▶ Press “ESC” button to exit main menu



### 7.3 Main menu - THET Timing heating

#### Function description:

Electrical heater, gas boiler or oil boiler can be integrated into solar system used as back-up of system, and they can be triggered automatically at preset time by preset temperature. Within a preset time section, when the temperature (T3) in top of tank drops below the preset switching-on temperature of this function, back-up heating starts to work, when T3 rises up to the preset turning off temperature, back-up heating is stopped. Within 24 hours, three time sections can be set with this controller.

#### Factory set:

The first time section: back-up heating function starts at 4:00 and ends at 5:00 am. Within this time section, the switch-on temperature is 40°C, switch-off temperature is 45°C.

The second time section: from 10:00 to 10:00 am, it means there is no back-up heating in this time.

The third time section: back-up heating function starts at 17:00 and ends at 22:00 pm. Within this time section, the switch-on temperature is 50°C, switch-off temperature is 55°C.

The switch-on temperature adjustable range: 3°C ~ (OFF-2°C)

The switch-off temperature adjustable range: (ON+2 °C) ~ 80 °C

If you want to shut off one timing heating, then you can set the turning on time and turning off time same value ( for example, the second time section no this function, then you can set turning on/off time is 10:00 ~ 10:00)

When time is outside of the preset time section, back-up heating doesn't work automatically even when the tank temperature reaches the switch –on temperature of heating.

#### Note:

- When there is no sensor installed in the top of tank (no T3 sensor), controller will take the signal of T2 (sensor in bottom of tank) automatically to control this function.
- The time in this controller is 24 hours, when you set time section, the switch-off time of heating should be later than switch-on time. For example: if you set the switch-on time of heating is at 17:00, but switch-off time of heating is 6:00, then this setting doesn't

take effect, that means within this time section, heating function doesn't work. The correct set is like following: it should be divided into two time sections, one time section is from 17:00 to 23:59, the other time section is from 00:00 to 06:00.

### Setup steps:

Under standby status, enter password to access main menu and select THET option. Detailed see 7.1 & 7.2 description.

▶ Press "SET" button, to access THET timing heating setup, "tH 1o 04:00" displays on screen, the start time of first time section can be set now.



- ▶ Re-press "SET" button, "04" of hour area blinks,
- ▶ Press **▲ ▼** button, to adjust hour of clock
- ▶ Press "SET" button again, "00" of minute area blinks
- ▶ Press **▲ ▼** button to adjust minute
- ▶ Re-press "SET" button to shift to temperature area, "40 °C" blinks
- ▶ Press **▲ ▼** button, to adjust switch-on temperature.
- ▶ Press "ESC" button to exit submenu.

▶ Press **▲** button, "tH 1F 05:00" displays, the shutdown time of first time section can be set now.







- ▶ Press "SET" button, hour area "05" blinks.
- ▶ Press **▲ ▼** button, to adjust hour of clock
- ▶ Press "SET" button again, "00" of minute area blinks
- ▶ Press **▲ ▼** button to adjust minute
- ▶ Re-press "SET" button to shift to temperature area, "45 °C" blinks
- ▶ Press **▲ ▼** button, to adjust switch-off temperature.

▶ Press "ESC" button to exit submenu or wait for 20 seconds to exit setup, parameter are saved automatically.





▶ Press **▲** button, "tH 2o 10:00" displays, the start time of second time section can be set now.





- ▶ Press "SET" button, hour area "10" blinks.
- ▶ Press **▲ ▼** button, to adjust hour of clock

- ▶ Press “SET” button again, “00” of minute area blinks
- ▶ Press   button to adjust minute
- ▶ Re-press “SET” button to shift to temperature area, “50 °C” blinks
- ▶ Press   button, to adjust switch- on temperature.
- ▶ Press “ESC” button to exit submenu

▶ Press  button, “tH 2F 10:00” displays, the shutdown time of second time section can be set now.





- ▶ Press “SET” button, hour area “10” blinks.
- ▶ Press   button, to adjust hour of clock
- ▶ Press “SET” button again, “00” of minute area blinks
- ▶ Press   button to adjust minute
- ▶ Re-press “SET” button to shift to temperature area, “55 °C” blinks





▶ Press   button, to adjust switch- off temperature.

▶ Press “ESC” button to exit submenu or wait for 20 seconds to exit setup , parameter is saved automatically.

▶ Press  button, “tH 3o 17:00” displays, the start time of third time section can be set now.

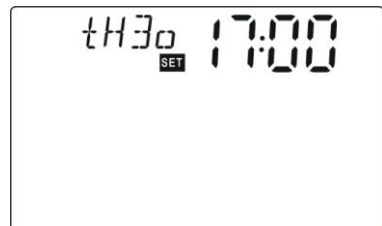

- ▶ Press “SET” button, hour area “17” blinks.
- ▶ Press   button, to adjust hour of clock
- ▶ Press “SET” button again, “00” of minute area blinks
- ▶ Press   button to adjust minute
- ▶ Re-press “SET” button to shift to temperature area, “50 °C” blinks



▶ Press   button, to adjust switch- on temperature.





▶ Press “ESC” button to exit submenu



▶ Press  button, “tH 3F 22:00” displays, the shutdown time of third time section can be set now.

- ▶ Press “SET” button, hour area “22” blinks.
- ▶ Press   button, to adjust hour of clock





- ▶ Press “SET” button again, “00” of minute area blinks
- ▶ Press   button to adjust minute
- ▶ Repress “SET” button to shift to temperature area, “55 °C” blinks
- ▶ Press   button, to adjust switch- off temperature.
- ▶ Press “ESC” button to exit submenu or wait for 20 seconds to exit setup , parameters are saved automatically

**Note:** when no gas or oil boiler is installed in system, electrical heater can be installed as back-up device, then, heating symbol  displays on the screen. when electrical heater is in operation status, symbol  blinks on screen.

If customer use electrical heater as back-up, please according to the power of electrical heater to equip corresponding safety devices like contactor and breaker with this controller, we strongly recommend equipping with SR802 device with this controller, (SR802 detailed technical data see in 13 part)



For example

## 7.4 Main menu - tCYC In three time sections temperature and time control DHW hot water

### Function description:

Solar system provides DHW hot water controlling function. To achieve this function, it needs an extra circulation ( connect output R4) and a temperature sensor which installed on the DHW return pipe( connect input T5). When controller monitors temperature of T5 is below the preset switch-on temperature, DHW pump is triggered until return temperature rises up to the switch-off temperature. If no sensor T5 is installed, DHW pump is only controlled by time, every day three time sections can be set, within a working time section, DHW pump works every 3 minutes, then stops for 15 minutes ( default), repeats same process during whole time section, this operation time and interval time can also be set personally.

Two parameters temperature and time are used to control DHW pump.

**Temperature precondition:** When the tank temperature T3 is 3°C higher than the switch-on temperature, temperature controlling function can be triggered.

**Every day 3 timing set:** Default time section set:

First time section: DHW Pump activated at 05:00 am, and deactivated at 07:00 am.

Second time section: DHW Pump activated at 11:00 am, and deactivated at 13:00 pm

Third time section: DHW Pump activated at 17:00 pm, and deactivated at 22:00 pm..

If you want to cancel a time section, then please set same time for the activated time and deactivated time, for example: set activate time is 05:00, and set deactivate time is also 05:00.

**Note:**

Temperature controlling is prior to time controlling for DHW pump, when controller detects return pipe T5 temperature, controller will trigger temperature controlled DHW pump, and at same time close time controlled DHW pump.

tCYC menu is used for setting time section, pump operation time and temperature, it is not to trigger DHW pump function, Access the main menu FUN, then submenu CIRC to activate this function ( detailed see 7.7.2)

once you install this return pipe sensor, please keep minimum distance of 1.5m to tank to avoid the large measure error.

**Setup steps:**



Under standby status, access to main menu tCYC, to set start and close time of every time section, DHW operation time and interval time, or switch-on/off temperature.

▶ Press “SET” button, access tCYC menu, “tC 1o 05:00” displays, start time of first time section can be set now.



▶ Press “SET” button, hour area “05” blinks.

▶ Press   button, to adjust hour of clock

▶ Press “SET” button again, “00” of minute area blinks

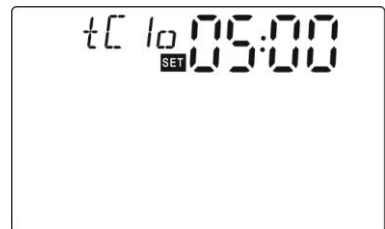



▶ Press   button to adjust minute





- ▶ Repress “SET”button to shift to operation time set, “03 Min ”blinks
- ▶ Press   button, to adjust DHW pump operation time. ( when installed T5 sensor, here will ask for adjust switch-on temperature)
- ▶ Press “ESC” button to exit submenu or wait for 20 seconds to exit setup , parameter are saved automatically.

▶ Press “  ” button, “tC 1F 07:00”displays, close time of first time section can be set.







- ▶ Press“SET”button, hour area “07”blinks.
- ▶ Press   button, to adjust hour of clock
- ▶ Press“SET”button again, “00”of minute area blinks
- ▶ Press   button to adjust minute



- ▶ Repress “SET”button to shift to operation interval time set, “15 Min”blinks
- ▶ Press   button, to adjust DHW pump interval time. ( when installed T5 sensor, here will ask for adjust switch-off temperature)
- ▶ Press “ESC” button to exit submenu or wait for 20 seconds to exit setup , parameter are saved automatically.

▶ Press “  ” button, “tC 2o 11:00”displays, start time of second time section can be set.



- ▶ Press“SET”button, hour area “11”blinks.
- ▶ Press   button, to adjust hour of clock
- ▶ Press“SET”button again, “00”of minute area blinks
- ▶ Press   button to adjust minute

▶ Repress “SET”button to shift to operation time set, “03 Min”blinks





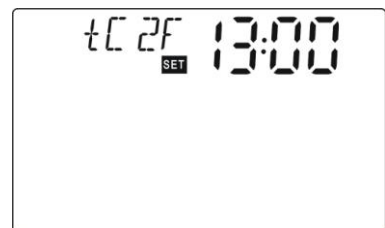

- ▶ Press   button, to adjust DHW pump operation time. ( when installed T5 sensor, here will ask for adjust switch-on temperature)





▶ Press “ESC” button to exit submenu or wait for 20 seconds to exit setup , parameter are saved automatically.

▶ Press “  ” button, “tC 2F 13:00”displays, close time of second time section can be set.









- ▶ Press“SET”button, hour area “03”blinks.

- ▶ Press   button, to adjust hour of clock
- ▶ Press “SET” button again, “00” of minute area blinks
- ▶ Press   button to adjust minute
- ▶ Repress “SET” button to shift to operation interval time set, “15 Min” blinks
- ▶ Press   button, to adjust DHW pump interval time. ( when installed T5 sensor, here will ask for adjust switch-off temperature)
- ▶ Press “ESC” button to exit submenu or wait for 20 seconds to exit setup , parameter are saved automatically.



- ▶ Press “  ” button, “tC 3o 17:00” displays, start time of third time section can be set.
- ▶ Press “SET” button, hour area “17” blinks.
- ▶ Press   button, to adjust hour of clock
- ▶ Press “SET” button again, “00” of minute area blinks
- ▶ Press   button to adjust minute
- ▶ Repress “SET” button to shift to operation time set, “03 Min” blinks



- ▶ Press   button, to adjust DHW pump operation time. ( when installed T5 sensor, here will ask for adjust switch-on temperature)
- ▶ Press “ESC” button to exit submenu or wait for 20 seconds to exit setup , parameter are saved automatically.

- ▶ Press “  ” button, “tC 3F 22:00” displays, close time of third time section can be set.
- ▶ Press “SET” button, hour area “22” blinks.
- ▶ Press   button, to adjust hour of clock
- ▶ Press “SET” button again, “00” of minute area blinks
- ▶ Press   button to adjust minute
- ▶ Repress “SET” button to shift to operation interval time set, “15 Min” blinks



- ▶ Press   button, to adjust DHW pump interval time. ( when installed T5 sensor, here will ask for adjust switch-off temperature)
- ▶ Press “ESC” button to exit submenu or wait for 20 seconds to exit setup , parameter are saved automatically.

## 7.5 Main menu - DT Temperature difference function

### Description:

Solar circuit pump R1 is triggered by the temperature difference function, so long as the temperature difference between collector and tank reaches the switch-on DT, solar circuit pump is triggered.



For example: the switch-on DT is 8°C, switch-off DT is 4°C, if the temperature in the bottom of tank is 20°C, then just when collector temperature rises up to 28°C, pump is triggered, and when collector temperature drops to 24°C, pump is ceased.

**Note:** the switch-on/off DT of 8°C and 4°C are standard system setting according to many years' experience, only in special application cases it needs to be changed, (e.g far distance heat transferring), normally it is recommend to use default set. Switch-on and switch-off DT are alternating set. To avoid mistake the minimum difference between two temperature differences ( $\Delta T_{on} - \Delta T_{off}$ ) is set as 2°C.

### Setup the switch-on/ switch - off temperature difference:

Under standby status, access main menu DT

▶ Press “SET” button, to access settings program of DT , “DT 1o 08°C” displays on screen, “08°C” blinks, the switch-on temperature difference can be set.

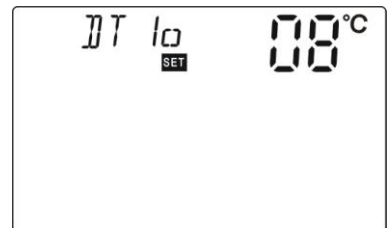

▶ Press “ ” button, to adjust the value of switch-on DT, adjustable range (OFF+2°C) ~20°C, factory setting is 8°C

▶ Press “ESC” button to exit this setting, parameter is saved automatically.



▶ Press “” button, to access setting first switch-off temperature difference, “DT 1F 04°C” displays on screen,

▶ Press “SET” button, “04°C” blinks,

▶ Press “ ” button to adjust the value of switch-off DT, adjustable range 0°C ~ (ON-2°C), factory set is 4°C.

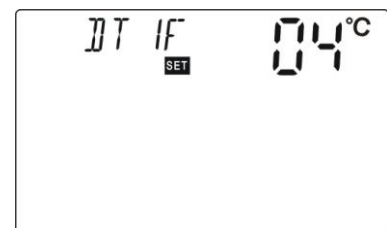

▶ Press “ESC” to exit menu, or wait for 20 seconds to exit automatically, the setup

parameters are saved automatically.

## 7.6 Main menu TEMP Temperature

For every system, the factory set parameters are in the best condition that is fully integrated into the entire solar system. But these parameters can also be set individually to cater the special requirements, please carefully observe the operation data of system components after setting.

### Note:

Parameters that can be set depend on the selected system, not all the parameters can be adjusted in a solar system.

Following submenu can be access though TEMP main menu.

<b>EMOF</b> Collector safety switch-off temperature	-----7.6.1
<b>EMON</b> Collector safety recovery temperature	-----7.6.1
<b>CMX</b> Maximum limited collector temperature (collector cooling function)	----- 7.6.2
<b>CMN</b> Low temperature protection of collector	----- 7.6.3
<b>CFR</b> Frost protection of collector	-----7.6.4
<b>REC</b> Tank recooling temperature	-----7.6.5
<b>SMX1</b> Maximum temperature of tank	----- 7.6.6
<b>C-F</b> Celsius and Fahrenheit temperature transferring	-----7.6.7

Function	Adjustable range	Factory set	Function exit temperature
EMOF Collector safety switch-off temperature	(ON+3°C) ~200°C	130°C	
EMON Collector safety recovery temperature	(OFF-3°C) ~197°C	120°C	
CMX Maximum limited collector temperature (collector cooling function)	90°C~180°C	110°C	107°C
CMN Low temperature protection of collector	0°C~90°C	OFF	

CFR Frost protection of collector	-10°C ~ 10°C	OFF	
REC Tank recooling temperature		OFF	
SMX1 Maximum temperature of tank 1	2°C ~ 95°C	60°C	58°C
C-F Celsius and Fahrenheit temperature transferring	C-F	°C	

### 7.6.1 Submenu - EMOF Collector safety switch-off temperature

#### Function description:

When collector temperature rises up to the limited temperature (EMOF), this function is activated, solar circulation pump is stopped in order to avoid the damage of system other components caused by the high temperature. When the temperature of collector rises up to this EMOF limited temperature ( factory set 130°C), solar circuit pump is ceased, but when collector temperature drops to the safety recovery temperature EMON ( factory set 120°C), solar circuit pump restarts, and at the same time this function is deactivated.

#### Setup steps:

##### EMOF Collector safety switch-off temperature

to access main menu TEMP, then select submenu EMOF, "EMOF 130°C" displays on screen

- ▶ Press "SET" button, parameter "130 °C" blinks.
- ▶ Press " ^ v " button, adjust EMOF temperature, adjustable range (EMON +3°C ~ 200 °C), factory set is 130 °C.
- ▶ Repress "SET" button, activate and deactivate this function, if deactivate the function, "EMOF - - -" displays on screen.





- ▶ Press "ESC" button to exit menu or wait for 20 seconds to exit, set parameters are saved automatically.

##### EMON Collector safety recovery temperature

to access main menu TEMP, then select submenu EMON, "EMON 120°C" displays on screen



- ▶ Press "SET" button, parameter "120 °C" blinks.



▶ Press “   ” button, adjust EMOF temperature, adjustable range (EMOF - 3°C~197 °C), factory set is 120 °C.

▶ Repress “SET” button, activate and deactivate this function, if deactivate the function, “EMON - - -” displays on screen.

▶ Press “ESC” button to exit menu or wait for 20 seconds to exit, set parameters are saved automatically.

When  lighted, and  blinks on the screen, it indicates this function is in activated, and at this moment temperature of tanks reaches to its maximum limited temperature



When only  blinks on the screen, it indicates collector temperature is over EMOF temperature, this function is activated, but temperature of tank doesn't reach to its maximum limited temperature

### 7.6.2 Submenu - CMX Maximum limited collector temperature( collector cooling function)

#### Function description:

The collector cooling function delays the vaporization of the heat transfer fluid. Shortly before reaching the maximum temperature of the collector, the solar pump starts working in order to cool down the heat transfer fluid using the heat losses occurring in pipelines and storage cylinder.



When tank temperature rises to its preset maximal temperature, solar circuit pump is ceased compulsively even the temperature difference is satisfied. If the sunshine is very good, as a result collector temperature will rise continuously, when collector temperature rises up to its maximal temperature, solar pump will be triggered again even at the case that tank temperature is already to its maximal temperature. And solar pump works until the temperature of collector drops since this reversed circulation or when tank temperature rises to its emergency temperature 95°C ( namely tank emergency stop temperature).

When  displays, and  blinks on the screen, it indicates that tank emergency temperature reaches, tank temperature is  $\geq 95^{\circ}\text{C}$

#### Setup steps:

To access main menu TEMP, then select submenu CMX , “CMX 110°C” displays on screen



- ▶ Press “SET” button, parameter “110°C” blinks.
- ▶ Repress “SET” button, activate and deactivate this function, if deactivate the function, “CMX - - -” displays on screen.
- ▶ Press “ ” button, to adjust the collector protection temperature, adjustable range (110°C ~ 190°C), factory set is 110°C
- ▶ Press “ESC” button to exit the menu or wait for 20 seconds to exit, parameters are saved automatically.

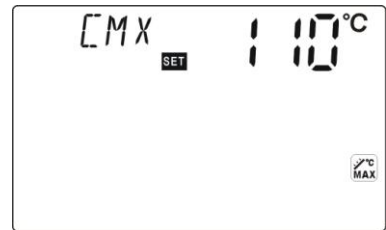

CMX signal displays on screen, it indicates that this function is in activated.



### 7.6.3 Submenu - CMN Low temperature protection of collector

#### Description:

When the temperature of collector is below preset CMN temperatures, solar circuit pump is ceased, even when the temperature difference between collector and tank exceeds the switch-on temperature difference, solar pump doesn't work yet. When temperature of collector is 3°C over the preset CMN temperature, solar circuit pump is restarted, controller exits this program.

#### Setup steps:

To access main menu TEMP, then select submenu CMN, “CMN-----” displays on screen, default set is off.

- ▶ Press “SET” button, default off signal “- - -” blinks on screen.
- ▶ Repress “SET” button, to activate and deactivate this function
- ▶ Press “ ” button, to adjust the low protection temperature of collector CMN, adjustable range (00°C ~ 90°C), after activate the function, factory set is 10°C
- ▶ Press “ESC” button to exit the menu or wait for 20 seconds to exit, parameters are saved automatically.



CMN signal displays on screen, it indicates that this function is in activated.

### 7.6.4 Submenu -CFR Frost protection of collector

**Description:**

In winter when the temperature of collector is below the preset frost protection temperature (factory set is 4 °C), Solar circuit pump is triggered. When tank temperature ( T2) drops to 6 °C, electrical heater is triggered , it works until tank temperature rises up to 20 °C, or it is ceased when program of CFR is exited. When collector temperature rises up to 7°C, solar circuit pump is ceased, program of CFR exits automatically.

This function is used in system, which use water as heat transfer liquid, to avoid the freezing of solar heat transfer fluid.

**Setup steps:**

To access main menu TEMP, then select submenu CFR, “CFR ----” displays on screen, default set is off.

▶ Press “SET” button, default off “- - -” blinks.

▶ Repress “SET” button, to activate or deactivate this function

▶ Press “ ^ v ” button, to adjust the frost protection function, adjustable range is (-10°C~10°C) , after function activated, default set is 4°C

▶ Press “ESC” button to exit the menu or wait for 20 seconds to exit, parameters are saved automatically.



CFR signal displays on screen, it indicates this function is activated.

**Note:** this function is only available in special solar system which using no-anti-freezing liquid; this kind of system is only suitable in area where the ambient temperature is near to 0°C in only few days. If safety requirement is very high , then anti-freezing is necessary, we suggest to use suitable anti-freezing liquid to avoid frost problem

### 7.6.5 Submenu - REC Tank recooling temperature

#### Description:

If temperature of first tank is over its maximum temperature, and at the same time, collector temperature is minimum 5°C lower than tank temperature, then solar pump is triggered, through this reversed circulation, tank temperature is reduced by heat loss occurs in collector, solar pump keeps working until tank temperature drops below its maximum temperature.

#### Setup steps:

To access main menu TEMP, then select submenu REC, "REC OFF" displays on screen, default set is off.

- ▶ Press "SET" button, parameter "OFF" blinks on screen
- ▶ Repress "SET" button to activate or deactivate this function, after function activated; factory set is "REC ON"
- ▶ Press "ESC" button to exit the menu or wait for 20 seconds to exit, parameters are saved automatically.



REC signal displays on screen, it indicates this function is activated.

### 7.6.6 Submenu - SMX1 Maximum temperature of tank



#### Description:

When the DT between collector T1 and Tank( T2) caters the switch-on DT of circulation, solar pump is triggered, but in order to avoid the high temperature inside tank, controller checks whether the temperature (T3) in top of tank is higher than maximum temperature of tank, when T3 is higher than preset SMX temperature, solar pump is ceased even at the case that DT caters condition. When tank temperature T3 drops and is 2°C below the SMX, solar pump restarts when DT caters condition.

#### Setup steps:

To access main menu TEMP, then select submenu SMX1, "SMX 1 60°C" displays on screen.

- ▶ Press "SET" button, parameter "60°C" blinks
- ▶ Repress "SET" button to activate and deactivate this function, if function deactivated, "SMX1 - - -" displays on the screen.

▶ Press “   ” button to adjust the value of maximum temperature of tank, adjustable range is (2°C~95°C) , default set is 60°C

▶ Press “ESC” button to exit the menu or wait for 20 seconds to exit automatically, parameters are saved automatically.

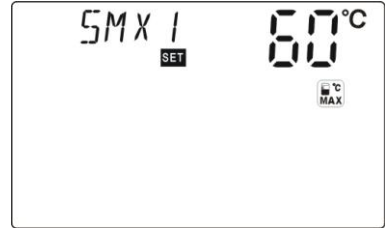

 SMX signal displays on screen, it indicates that this function is in activated.

### 7.6.7 Submenu - C-F Celsius and Fahrenheit temperature transferring

#### Setup steps:

To access main menu TEMP, then select submenu C-F, “C\_F °C” displays on screen.

▶ Press “SET” button, parameter “C” blinks on the screen.

▶ Press “  ” button, to select between Celsius and Fahrenheit temperature, factory set is °C

▶ Press “ESC” button to exit menu or wait for 20 seconds to exit automatically, parameters are saved automatically.

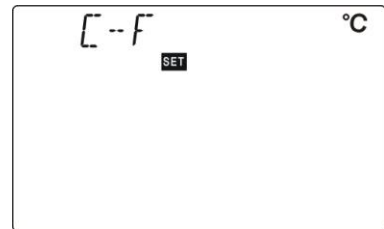

### 7.7 Main menu - FUN Auxiliary function

The auxiliary function of this controller can be set under “FUN” submenu; it is possible to activate several auxiliary functions at the same time.

Activated or deactivated status for following auxiliary functions in submenu is different.

#### Following submenu can be accessed through menu “FUN”

- DVWG Anti-Legionella function -----7.7.1
- CIRC Activate and deactivate DHW hot water circulation pump -----7.7.2
- nMIN Solar circuit pump speed adjusting (RPM speed controlling) -----7.7.3
- DTS Standard temperature difference (for circuit pump speed adjusting) ----- 7.7.3.1
- FMAX Flow rate-----7.7.4
- AHO/AHF Tank thermostate function-----7.7.5

### 7.7.1 Submenu - DVWG Anti-Legionella function

#### Description:

In order to avoid occurring bacteria in water tank when the temperature of tank is lower for a long time, controller checks the temperature of tank every 7 days in a period automatically, if the temperature of tank is never over 70°C during this period, then at the factory set default time 01:00 on the seventh day of the period auxiliary heating system is triggered automatically to heat water until it rises up to 70°C, bacteria is killed by high temperature, whereafter function is deactivated.

#### Setup steps:

To access main menu FUN, then select submenu DVWG, “DVWG OFF” displays on screen. Default set is “OFF”.

▶ Press “SET” button, parameter “OFF” blinks on the screen.

▶ Reprress“SET”button, “DVWG ON” blinks on the screen, function is activated.

▶ Press “ESC” button to exit the menu or wait for 20 seconds to exit , parameters are saved automatically.



### 7.7.2 Submenu - CIRC Activate and deactivate DHW hot water circulation pump

#### Setup steps:

To access main menu FUN, then select submenu CIRC, “CIRC OFF” displays on screen, factory set is off.

▶ Press “SET” button, parameter “OFF” blinks on screen.

▶ Reprress “SET” button, function is triggered, “ CIRC ON” blinks on screen

▶ Press “ESC” button to exit the menu or wait for 20 seconds to exit , parameters are saved automatically.

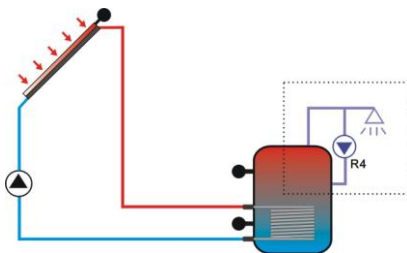

Signal circled in dashed frame displays on the screen, it indicates this function is in operating.

### 7.7.3 Submenu - nMIN Solar circuit pump speed adjusting (RPM speed controlling)

#### Description:



R1 output can be configured either as RPM controlled output or as simple on/off output. When this function is activated, the output is RPM controlled output; when this function is deactivated, the output becomes a normal on/ off output.

**Normal on/ff output:** circuit pump speed controlling is deactivated, pump is operated with a fixed speed ( 100%), and flow rate is not changed.

**RPM control output:** (speed controlling is activated), the control attempts to maintain a constant temperature difference between collector and tank. The pump performance is continuously adjusted and the volume flow pumped is increased or reduced, depending on the temperature difference.

#### Setup steps:

To access main menu FUN, then select submenu nMIN, “nMIN 30” displays on screen.

- ▶ Press “SET” button, parameter “30” blinks on the screen
- ▶ Press “ ” button, to adjust speed of circuit pump, adjustable range (30~100%), factory set is 30%
- ▶ Press “ESC” button to exit the menu or wait for 20 seconds to exit, parameters are saved automatically.

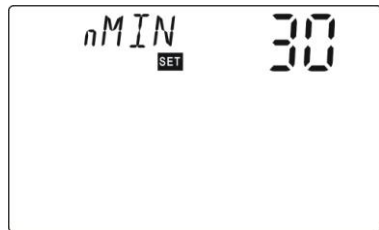

#### 7.7.3.1 Submenu - DTS Standard temperature difference (for circuit pump's speed adjusting)

#### Description:

When the switch-on temperature difference ( $\Delta$  TON) reaches, solar pump is triggered, and then within 10 seconds, pump speed reaches to its minimum speed (30%). Whereafter, controller checks continuously, when the standard temperature difference (DTS) reaches, the speed of pump is adjusted automatically, under the precondition that maximum flow rate isn't exceeded, pump's speed is changed slightly to keep this standard temperature difference (DTS), and therefore to gain the maximum thermal energy. Speed adjusting of circulation pump is based on preset maximum flow rate and standard temperature difference

( DTS). If temperature difference drops to the switch-off TD( $\Delta T$  OFF), circuit pump is ceased.

**Setup steps:**

To access main menu FUN, then select submenu DTS, "DTS 08°C" displays on the screen



▶ Press "SET" button, parameter "08°C" blinks on the screen

▶ Press " ^ v " button, to adjust standard TD, adjustable range ( 2°C~30°C ) , factory set is 08°C

▶ Press "ESC" button to exit the menu or wait for 20 seconds to exit, parameters are saved automatically.

**7.7.4 Submenu - FMAX Flow rate**

FAMX: Flow rate L/min. adjustable range: (0.1~20) L/min, increase rate 0.1L per time, factory set is 2.0L/min

**Setup steps:**

To access main menu FUN, then select submenu FMAX, "FMAX 2.0" displays on screen.



▶ Press "SET" button, parameter "2.0" blinks on the screen

▶ Press " ^ v " button to adjust parameter of flow rate. adjustable range (0.1~20)

▶ Press "ESC" button to exit the menu or wait for 20 seconds to exit , parameters are saved automatically.

**7.7.5 Submenu – AHO/AHF Tank thermostat function**

**Function decription:**

Thermostat function is a independent system, it is separated from solar system. It is used to control auxiliary heating or to transfer redundant thermal energy from tank for keeping constant temperature in tank. When AHO < AHF, this function is used to control auxiliary heating, when AHO > AHF, this function is used to transfer tant redundant energy, temperature is controoled by T4, output terminal is R2.

**Setup steps:**

To access main menu FUN, then select submenu AHO ,  
 “AHO-----” displays on screen. Factory set is off



- ▶ Press “SET” button, “AHO-----” blinks on the screen,
- ▶ Repress “ ^ v ” button, to adjust switch-on temperature , adjustable range :0 ~95°C.
- ▶ Press “ESC” button to exit the menu.

▶ Press “ ^ ” button, “AHF 07°C-----” blinks on the screen.



- ▶ Repress “ ^ v ” button, to adjust switch-off temperature , adjustable range :0 ~95°C.
- ▶ Press “ESC” button to exit the menu or wait for 20 seconds to exit, parameters are saved automatically.

AH O: Switch-on temperature of thermostat, adjustable range : 0~95°C, factory set: 2°C  
 AH F: Switch-off temperature of thermostat, adjustable range : 0~95°C, factory set: 7°C

 AHO signal displays on the screen, indicates this function is in operation.

**Note:**

- Temperature sensor (T4) is not included within standard delivery, it should purchase separately.

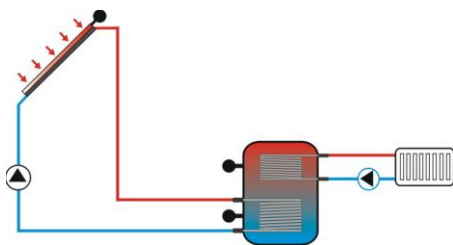

Heat loss

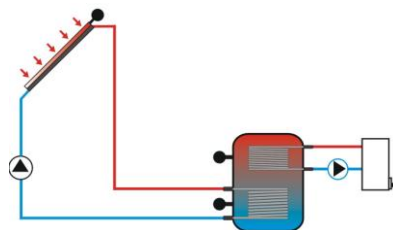

Heating



## 7.8 Mainmenu - HND manual function

When you use this controller first time or when you make system commissioning, controller's output ( R1,R2, R4,,H1) can be manually set as On/Off output.

### Setup steps:

To access main menu HND,

▶ Press “SET” button, “HND1 off” blinks on the screen, it is ready to start R1 manual set.

▶ Reprress “SET” button, “HND1 on” blinks, output of R1 is activate.

▶ Reprress “SET” button again,, “HND1 off” blinks, output of R1 is close.

▶ Press “ESC” button to exit R1 set.



▶ Press “” button, “HND2 off” blinks on the screen, it is ready to start R2 manual set.

▶ Reprress “SET” button, “HND2 on” blinks, output of R2 is activate.

▶ Reprress “SET” button again,, “HND2 off” blinks, output of R2 is close.

▶ Press “ESC” button to exit R2 set.



▶ Press “” button, “HND3 off” blinks on the screen, it is ready to start R4 manual set.

▶ Reprress “SET” button, “HND3 on” blinks, output of R4 is activate.

▶ Reprress “SET” button again,, “HND3 off” blinks, output of R4 is close.

▶ Press “ESC” button to exit R4 set.



▶ Press “” button, “HND4 off” blinks on the screen, it is ready to start H1 manual set.

▶ Reprress “SET” button, “HND4 on” blinks, output of H1 is activate.



- ▶Repress “SET” button again,, “HND4 off” blinks, output of H1 is close.
- ▶Press “ESC” button to exit H1 set

**Note:** when manual function is activated, signal  displays, operation lasts 15 minutes output is closed automatically. And controller exits manual function.

## 7.9 Mainmenu - PASS Password setup

### Setup steps:

To access main menu PASS,

▶Press “SET” button, “PWDC 0000” shows on the screen, left digital blinks to ask for enter current password, factory set password is “0000”

▶Press “ ^ v ” button to enter first digital,

▶Repress “SET” button, second digital blinks,

▶Press “ ^ v ” button to enter second digital,

▶Repress “SET” button, third digital blinks,

▶Press “ ^ v ” button to enter third digital,

▶Repress “SET” button, fourth digital blinks,

▶Press “ ^ v ” button to enter fourth digital,



▶Press “SET” button, “PWDC 0000” shows on the screen, ask for enter new password, doing like above description to enter new password.



▶Repress “SET” button, “PWDC 0000” shows on the screen, ask for reenter new password, doing like above description to confirm the new password. Then “PWOK” displays on the screen, password is rightly set.

▶Press “ESC” button to exit PASS manu, or wait for 20 seconds to exit, parameters are saved automatically.



**Warning:** if you forget password, then it can't recover, but we can firstly recover password to factory set, then doing like above steps to reenter new password.

Steps for recovering to factory set password :

Switch-off power of controller, press “SET” button and hold on, then switch-on power, buzzer makes “du----“ 3 times, release “SET” button, password recovers to factory set ( 0000), then you can set a new password again.

### 7.10 Mainmenu - RSET, Recovery to factory set

#### Setup steps:

To access main menu RSET,

▶ Press “SET” button, “ YES” shows on the screen,  
▶ Press and hold on “SET ” button, buzzer makes “du----“ 3 times, then release “SET” button. Thus parameter is recovered to factory set, you can reset parameters on require.



▶ Press “ESC” button to exit RSET menu, or wait for 20 seconds to exit, parameters are saved automatically.

### 7.11 On/Off button

Under standby status,

▶ Press “ ⏻ “ button for 3 seconds, controller is switched – off, “OFF” displays on the screw.

▶ Repress “ ⏻ “ button , controller is switched-on again.

### 7.12 Holiday function



#### Functional description:

This function activates at night, solar liquid will flow from storage tank to collector, by this reversed circulation tank’s temperature will be reduced in night, this prevents solar system from high thermal loads problem which caused by completely heated storage tank. The function is activated at night between 10 pm and 6 am, when the collector temperature drops 8 °C below the storage tank temperature (T2), solar circuit pump starts to release heat by reversed circulation, when the temperature of collector is 2 °C below the tank temperature, and solar circuit pump is ceased.

**Activate this function if:**

- You intend to be absent for an extended period (holiday)
- No hot water is required for an extended period.
- When the temperature in bottom of storage tank drops below 35°C.

**Activate/ deactivate this function:**

- ▶ Press “” button for a long time until the signal of holiday function displays on the screen, and then holiday function is activated.
- ▶ Repress “” button, signal disappears, holiday function is deactivated.

**Note:**

This function is only activated when you are not at home for long time, when you come back; please make sure to deactivate it.



### 7.13 Manual heating



**Functional decription:**

Electrical heater, gas or oil boiler can be as back-up devices in a solar system, this controller can be used as a thermostat, when controller gets temperature signal from top of tank (T3) is 2°C below the preset temperature, back-up heating device will be triggered. When temperature of top part tank (T3) reaches to the preset temperature, heating is ceased.

Conditions for triggering manual heating function: the setting temperature should be 2°C higher than tank temperature.

**Activate/deactivate the function:**

- ▶ Press “” button, temperature “60°C” blinks on the screen.
- ▶ Press “ ” button to adjust switch-on temperature, adjustable range 10°C~80°C, factory set is 60°C.



After 20 seconds, this function is activated, manual heating signal  displays on the screen, and heating  signal blinks also.

► Press “  ” button again, to switch-off manual heating function.

**Note:** manual heating can only heat tank one time, after manual heating is triggered, when temperature of tank rises up to the preset temperature, manual heating ceases, and manual heating function will be deactivated automatically, if customer wants to heat again, you need redo according to above steps.

#### 7.14 Temperature query function

Under standby status,

► Press “   ” button can check the value of temperature sensors T1~ T7, time and week.

When checking temperature, T1 ~ T7 will display one by one, corresponding sensor signal  blinks, tank desired temperature is TST.

**Note:** due to difference system the values you can check are different.

## 8. Protection function

### 8.1 Memory protection

In case power failure occurs, controller keeps the parameter settings unchanged.



### 8.2 Screen protection





When no any press on button for 3 minutes, screen protection is activated automatically, and then LCD lighting lamp is switched-off. Through press any button to light LCD lamp again.

## 9. Trouble shooting

### 9.1 Trouble protection





a. When there is a break or short circuit between the connection of temperature sensors, controller switches off the corresponding functions and corresponding output signals, at the same time error signals  are showed on the display. If control unit does not work correctly, please check following points.

► Press “   ” button to check error code, “  ” signal displays on the LCD screen

Error message on LCD screen	Meaning	Cause of error	Error rectification
 T1 --	T1 sensor problem	Sensor open or short	Check resistance value, replace
 T2 --	T2 sensor problem	Sensor open or short	Check resistance value, replace
 T4 --	T4 sensor problem	Sensor open or short	Check resistance value, replace
 T5 --	T5 sensor problem	Sensor open or short	Check resistance value, replace
 T6 --	T6 sensor problem	Sensor open or short	Check resistance value, replace

## 9.2 Trouble checking

The controller is a quality product, conceived for years of continuous trouble-free operation. If a problem occurs, the cause of the problem very often lies not in the controller but in the peripheral components. The following description of some well-known problems should help the installer and operator to isolate the problem, so that the system can be placed back into operation as quickly as possible and to avoid unnecessary costs. Of course, not all possible problems can be listed here. However, most of the normal problems encountered with the controller can be found in the list below, only return the controller to seller when you are absolutely sure that none of the problems listed below is responsible for the fault.

Symptoms	Secondary symptoms	Possible cause	Procedure
Controller does not appear to function at all	Display shows nothing, no display illumination	Controller power supply is interrupted or program is out of work	Check the controller power cable, fuse
The solar pump doesn't operate, despite the fact that switch-on conditions are satisfied	The pump symbol in the display blinks	Pump power supply is interrupted	Check the pump power cable
Pump doesn't operate	The pump symbol in the display doesn't blink.  Lighted or  blinks	The maximum storage tank temperature (SMX) has been reached Tank reaches 95°C	No fault
	 Lighted or  blinks	The maximum collector temperature (EMOF) has been reached.	No fault

	 T1 - - - Error message displays on the screen	Fault (short circuit or open circuit) in a temperature sensor	On the controller, request the current values from all connected temperature sensors, replace all defective sensors and /or cabling.
The solar pumps operated, despite the fact that the switch-on conditions are not satisfied.	The pump symbol in the display blinks.	Holiday function or Frost protection function or tank re-cooling function is activated.	No problem, it is normal. If necessary to deactivate the corresponding functions.
One function can't be activated	There is no function selection in submenu	All inputs and outputs are used; inputs and outputs can't be used doubly.	No fault on controller
Pump works, but flow rate shows 0.0L/min	No filter installed on flow and return pipe进	Blade of electrical flow meter is logged .	Dismount the pipe from solar station, clean pipe, until flow rate shows on display,



**Warning!** Remove the device from the mains supply before opening the case

A potentially defective sensor can be checked using an ohmmeter. To do this, the sensor must be disconnected, its resistance measured, and the value compared with the figures in the table below, small deviation ( $\pm 1\%$ ) is acceptable,

PT1000 resistance value

°C	0	10	20	30	40	50	60	70	80	90	100	110	120
Ω	1000	1039	1077	1116	1155	1194	1232	1270	1309	1347	1385	1422	1460



NTC 10K B=3950 resistance value

°C	0	10	20	30	40	50	60	70	80	90	100	110	120
Ω	33620	20174	12535	8037	5301	3588	2486	1759	1270	933	697	529	407

## **10 Quality Guarantee**

Manufacturer provides following quality responsibilities to end-users: within the period of quality responsibilities, manufacturer will exclude the failure caused by production and material selection. A correct installation will not lead to failure. When a user takes incorrect handling way, incorrect installation, improper or crud handling, wrong connection of sensor in system and incorrect operation, the quality responsibility is invalid for them.

The warrantee expires within 12 months after the date of purchasing the controller.

## 11. Technical data

Specification	SR961,SR962
<b>Controller part</b>	
Power supply	AC230V±10%
Power consumption	< 4W
Accuracy of temperature measuring	±2°C
Range of collector temperature measuring	-10~200°C
Range of tank temperature measuring	0~100°C
Suitable power of pump or valve	3个, ≤ 600W
Suitable power of electrical heater	1个, ≤ 1500W
Inputs	Total 5 sensor, thereof 3 sensors are standard, 2 sensors are optional. 1 x Pt1000 sensor (≤500°C) for collector T1 (silicon cable≤280°C), 2 x NTC10K, B3950 sensor (≤ 135°C) for tank, (PVC cable ≤105°C), Optional: 2 x NTC10K, B3950 sensor (≤ 135°C) for tank, (PVC cable ≤105°C),
Outputs	2 relays, for circulation pumps; 1 relay for electrical heater
Ambient temperature	-10~50 °C
Water proof grade	IP42
<b>Solar station parts</b>	
Appearance of solar station	420 mm×280mm×140mm

## 12. Delivery scope

Lists	SR961,SR962
Solar station	1
Operation manual	1
PT1000 sensor (size: $\phi 6*50\text{mm}$ ,cable length1.5m)	1
NTC10K (size: $\phi 6*50\text{mm}$ ,cable length3m)	2
Plastic expansion screw	3 sets
Clamp & Screw	1 set
Fuse AC250V/6.3A	1 piece

## 13. Device matchable to this controller

- PT1000 sensor ( A01) for high temperature use, for collector

Size:PT1000,  $\phi 6*50\text{mm}$ , 1.5m silicon cable

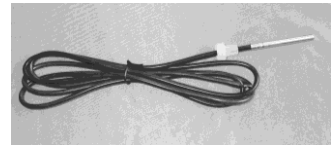

- NTC10K B=3950 sensor ( A02 ) for tank,

Size:NTC10K, B=3950,  $\phi 6*50\text{mm}$ , 1.5m plastic cable

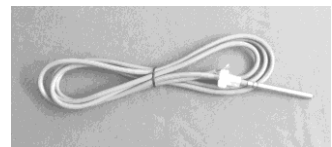

- Stainless steel thermowell (A05)

Size:G1/2", male thread,  $\phi 8*200\text{mm}$

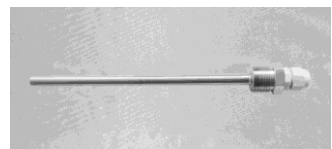

- High power unit (SR802)

Technical data:

Dimension: 100mmx100mmx65mm

Power supply: 180V~264V/AC 50/60Hz

Suitable power:  $\leq 4000\text{W}$

Available ambient temperature: -10 ~ 50°C

Waterproof grade: IP43



- SR802 connection example

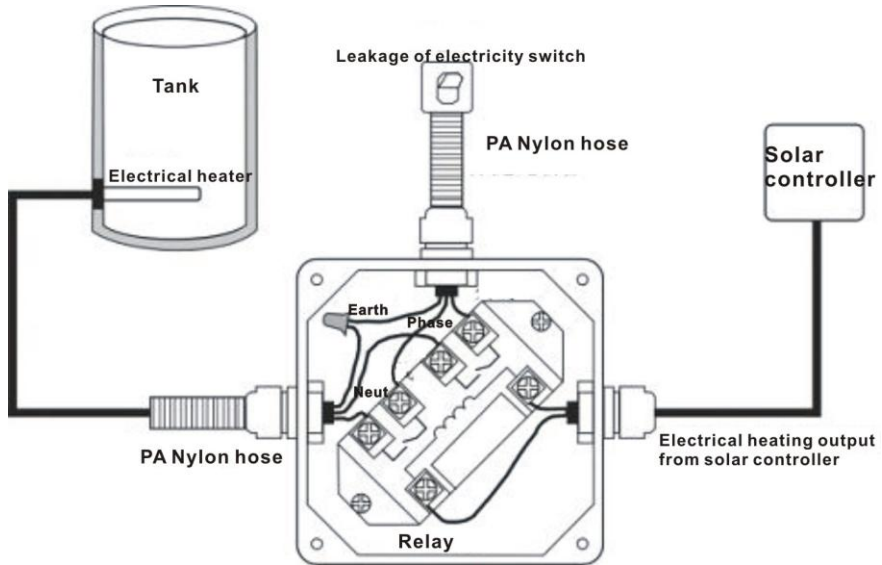

**Note: only qualified person can connect SR802**